



Specifications:

39W, PAR30 Metal Halide Spot with metal baffle and integral ballast for 120 volt flexible track system.

Features:

1. **Threaded Coupling Cap:** made of die cast aluminum; locks coupler onto track.
2. **Hinged Extrusion Coupler:** made of die cast aluminum; connects fixture to track.
3. **Swivel:** 358 Degree rotation for horizontal adjustment.
4. **Locking Screw:** 3mm set screw; used to lock vertically in place; up to 90 degrees of adjustment.
5. **Die Cast Socket Housing:** includes porcelain socket, 4KV rated medium base, high temperature wire.
6. **Post:** made from aluminum d-bar; used to lock lamp cowl in place; tightens down with 3mm set screw.
7. **Lamp Cowl:** made of die cast aluminum; 4-3/4" in diameter.
8. **Metal Baffle:** made of die cast aluminum; 3-5/8" in diameter; rests inside lamp cowl; contains internal cross-blade louver. Allow the use of one (1) media accessory.
9. **Ballast Box:** made of extruded aluminum; 2-3/8" x 2-3/8" x 9-3/4".
10. **Ballast:** 39w electronic metal halide ballast. Input voltage...120V 60Hz, input current...0.35A. Power factor...0.99; *FOR USE WITH 20W CERAMIC METAL HALIDE LAMPS ONLY.
11. **Compliances:** UL/C listed.

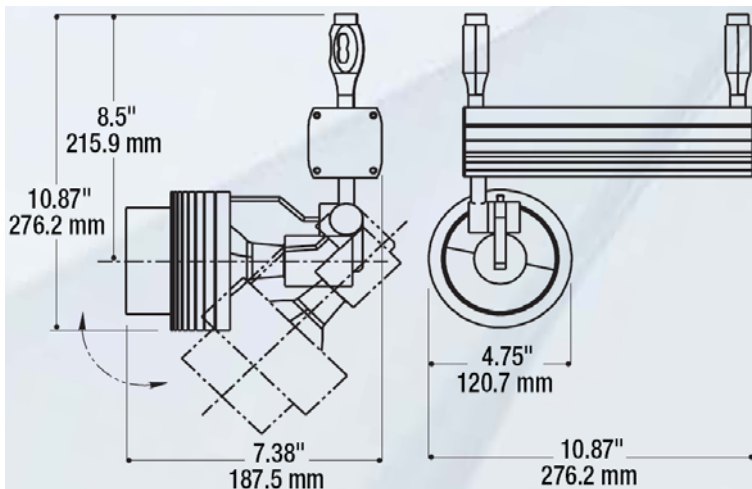

Ordering Information

Part Number	Lamp	Trim Style	Trim Finish
530.520	39W PAR30 Ceramic Metal Halide	SPOT w/Metal cross-baffle	Satin Aluminum

Use with Flexsion Track System.
Lamps Not Included

Ardee Lighting reserves the right to change product specifications without prior notification.

Ardee Lighting		
5/23/2008	PO Box 1769 · 639 Washburn Switch Rd · Shelby · NC 28151 T 704. 482.2811 F 800.275.1544 E ardee@jjishelby.com www.ardeelighting.com	222309