



Job No: _____ Type: _____
 Cat. No. _____
 Notes: _____

LOW VOLTAGE TRANSFORMERS

TW Series 2000w

ISOLATION TYPE TRANSFORMER FOR REMOTE INSTALLATION APPLICATIONS

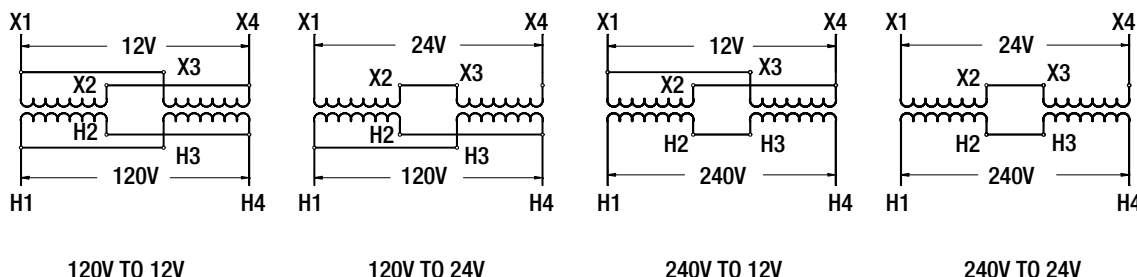
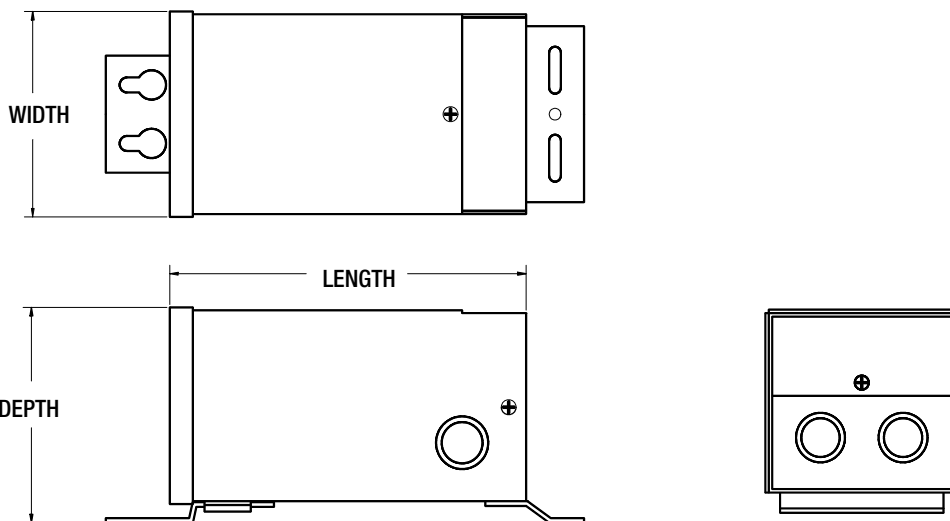

FEATURES

DIMENSIONS

Height: 11.75"
 Width: 5.5"
 Depth: 5.38"
 Weight: 39 lbs.

RATINGS KVA: 2.0

PHASE 1

FREQUENCY 60 Hz

SOUND LEVEL 40 db. (Ave.)

INSULATION CLASS 180°C

TEMPERATURE RISE 115°C

EFFICIENCIES 90.7% @ 100% Load,
 91.4% @ 75% Load

ENCLOSURE NEMA Type 3R,
 UL Type 2 - Min. field installed clearances:
 Side 4", Vertical 4".

HIGH VOLTAGE, PRIMARY 120 x 240 volts

LOW VOLTAGE, SECONDARY 12/24 volts

COMPLIANCES UL Listed, CSA Certified
 for use with Ardee Lighting low voltage
 lights.

ORDERING INFORMATION

TW2000

We reserve the right to change details of design, materials, and finish.