



Job No: _____ Type: _____
 Cat. No. _____
 Notes: _____

LOW VOLTAGE TRANSFORMERS

TW Series 1500w

ISOLATION TYPE TRANSFORMER FOR REMOTE INSTALLATION APPLICATIONS

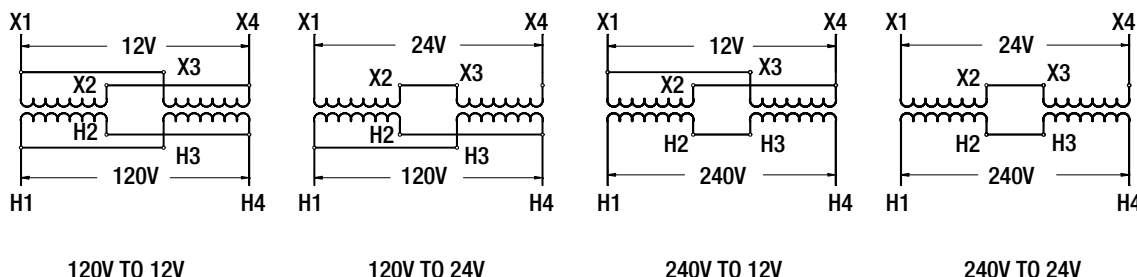
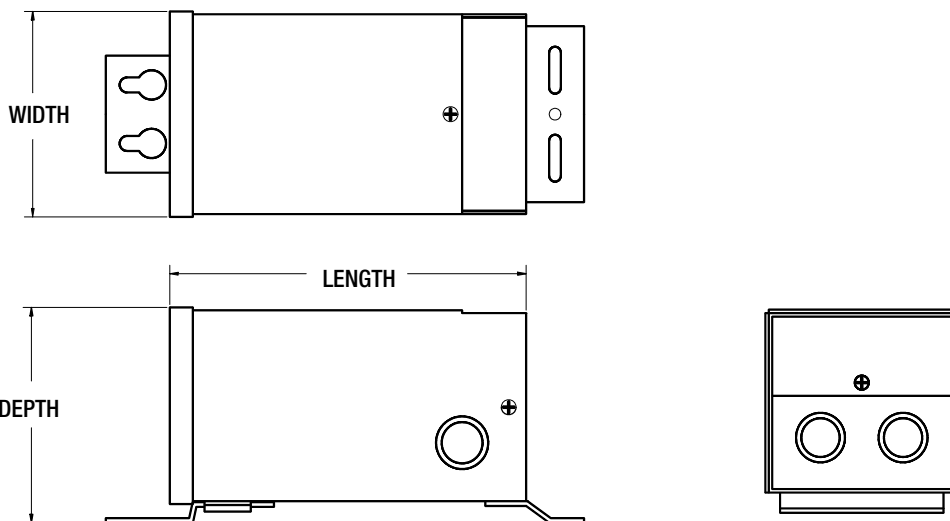

FEATURES

DIMENSIONS
 Height: 10.25"
 Width: 5.5"
 Depth: 5.25"
 Weight: 32 lbs.

RATINGS KVA: 1.5

PHASE 1

FREQUENCY 60 Hz

SOUND LEVEL 40 db. (Ave.)

INSULATION CLASS 180°C

TEMPERATURE RISE 115°C

EFFICIENCIES 92.3% @ 100% Load,
 92.5% @ 75% Load

ENCLOSURE NEMA Type 3R,
 UL Type 2 - Min. field installed clearances:
 Side 4", Vertical 4".

HIGH VOLTAGE, PRIMARY 120 x 240 volts

LOW VOLTAGE, SECONDARY 12/24 volts

COMPLIANCES UL Listed, CSA Certified
 for use with Ardee Lighting low voltage
 lights.

ORDERING INFORMATION

TW1500

We reserve the right to change details of design, materials, and finish.